

Data Sheet



Article number: 25030220062201

Description: Kleedrive T3C 200L2-6 22.0KW 900 rpm
3x400/690V 50HZ IP55 B3 Eff=92,2% Klemkasse venstre side DE

Measures

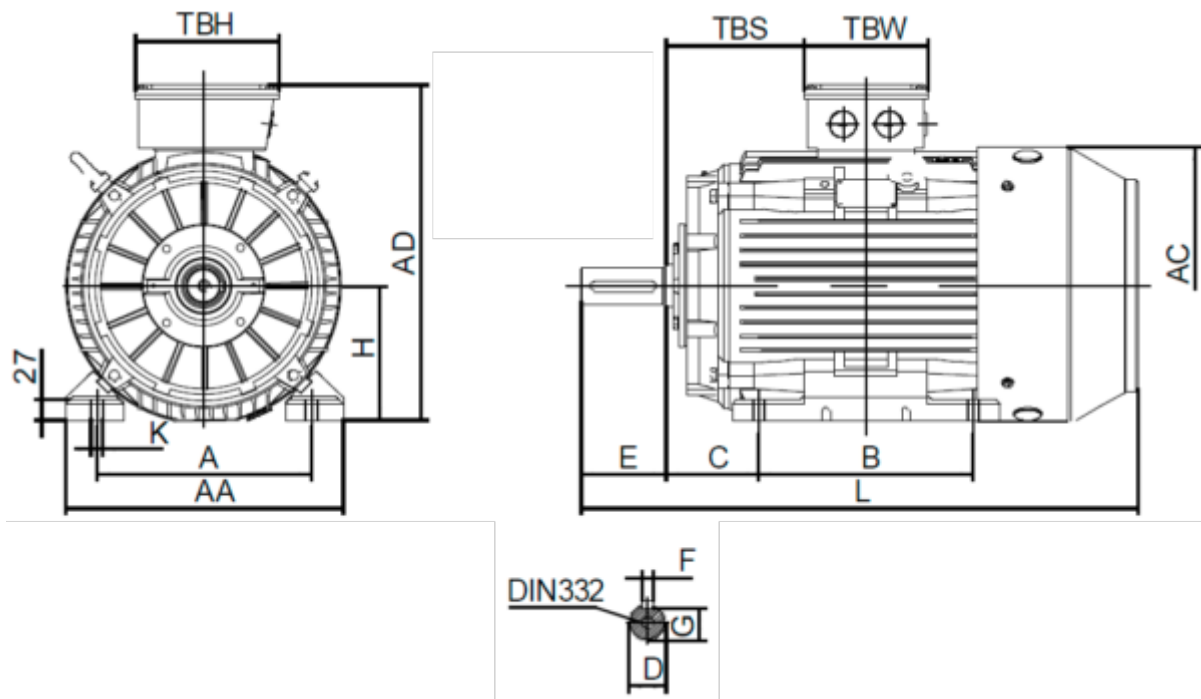

A = 318	F = 16	TBW = 186
AA = 393	G = 49	
AC = Ø399	H = 200	
AD = 500	HD = 300	
B = 305	K = Ø19	
C = 133	L = 768.5	
D = Ø55	TBH = 233	
E = 110	TBS = 192	